

Article number: 0102073

Description: Retaining ring J56 DIN472
Spring steel

Measures

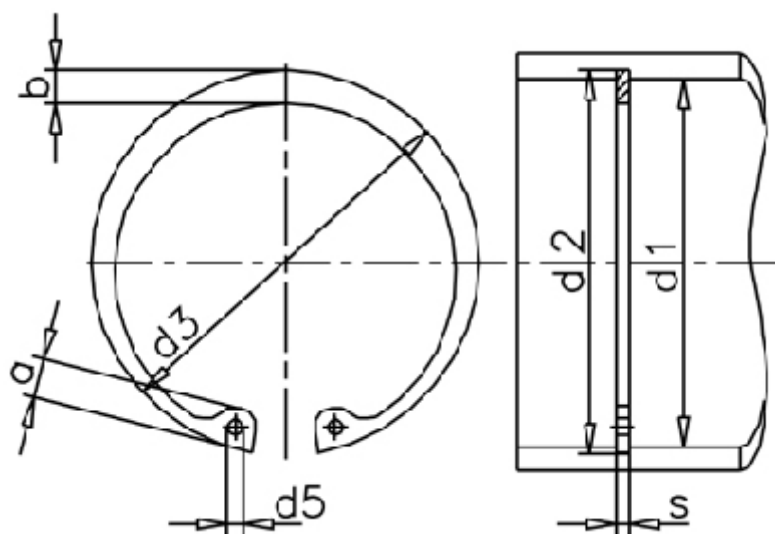

a max	= 6.8	FN kN	= 45.20	t	= 1.50
AN mm ²	= 271.0	FRg kN	= 12.6	tol	= +0,30
b	= 5.1	FR kN	= 60.3	tol	= +1,10-0,46
d1	= 56	g	= 2.0	tol	= -0.07
d2	= 59.0	K kN-mm	= 111.0	Tong	= ZGJ-3
d3	= 60.20	m min	= 2.15	Weight kg/1000	= 8.80
d5 min	= 2.5	Nominal drive	= 4.5		
Description = J 56		s	= 2.00		